



Features:

- Constant voltage/ PWM Output
- Leading & Trailing edge dimmable
- AC input: 200-240VAC
- Built-in active PFC function
- Efficiency up to 87%
- Protections: Short circuit/ Over loading/ Over current/ Over temperature
- Full protection aluminium housing
- Cooling by free air convection
- Suitable for LED lighting and moving signs



Models

ELED-200P-12T

ELED-200P-24T

Output Specifications

	ELED-200P-12T	ELED-200P-24T
Output Voltage	12V	24V
Voltage Tolerance	±0.5V	
Output Current	16.6A	8.3A
Rated Power	200W	

Input Specifications

Input Voltage	200-240VAC	
Frequency Range	47-63Hz	
Inrush Current	55A (Twidth=220µs 230VAC)	
Full Load Efficiency (Typ.)	86%	87%
AC Current (Max.)	1.4A	
Leakage Current	<0.50mA	
Power Factor	PF>0.97/200VAC PF>0.97/230VAC PF>0.97/240VAC (Full Loading)	

Protection

Short Circuit	Shut down o/p voltage, re-power on to recover after fault condition is removed
Over Loading	≤120%, shut down o/p voltage, re-power on to recover
Over Temperature	100°C± 10°C shut down o/p voltage, re-power on to recover

Environment

Working Temperature	-40~+60°C (Refer to derating curve)
Working Humidity	20-95% RH, non-condensing
Storage Temperature, Humidity	-40~+80°C, 10-95% RH
Temperature Coefficient	±0.03%/°C (0-40°C)

Environment

Vibration 10-500Hz, 5G 12min./ 1 cycle, period for 72min.each along X, Y, Z axes

Safety & EMC

Safety standards	EN61347-1, EN61347-2-13
Withstand Voltage	I/P-O/P:3.75KVAC I/P-FG:1.88KVAC O/P-FG:0.5KVAC
Isolation Resistance	I/P-O/P I/P-FG O/P-FG: 100MΩ/500VDC/25°C/70%RH
EMC Emission	Compliance to EN55015, EN61000-3-2, 3 (>60%load)
EMC Immunity	EN61000-4-2,3,4,5,6,11, EN61547

Other Specifications

Weight	1.45 kg
Size	265 x 78 x 47 mm
Packing	265 x 83 x 65 mm (inner box), 340 x 280 x 185 mm (10PCS/CTN)

Mechanical Specifications

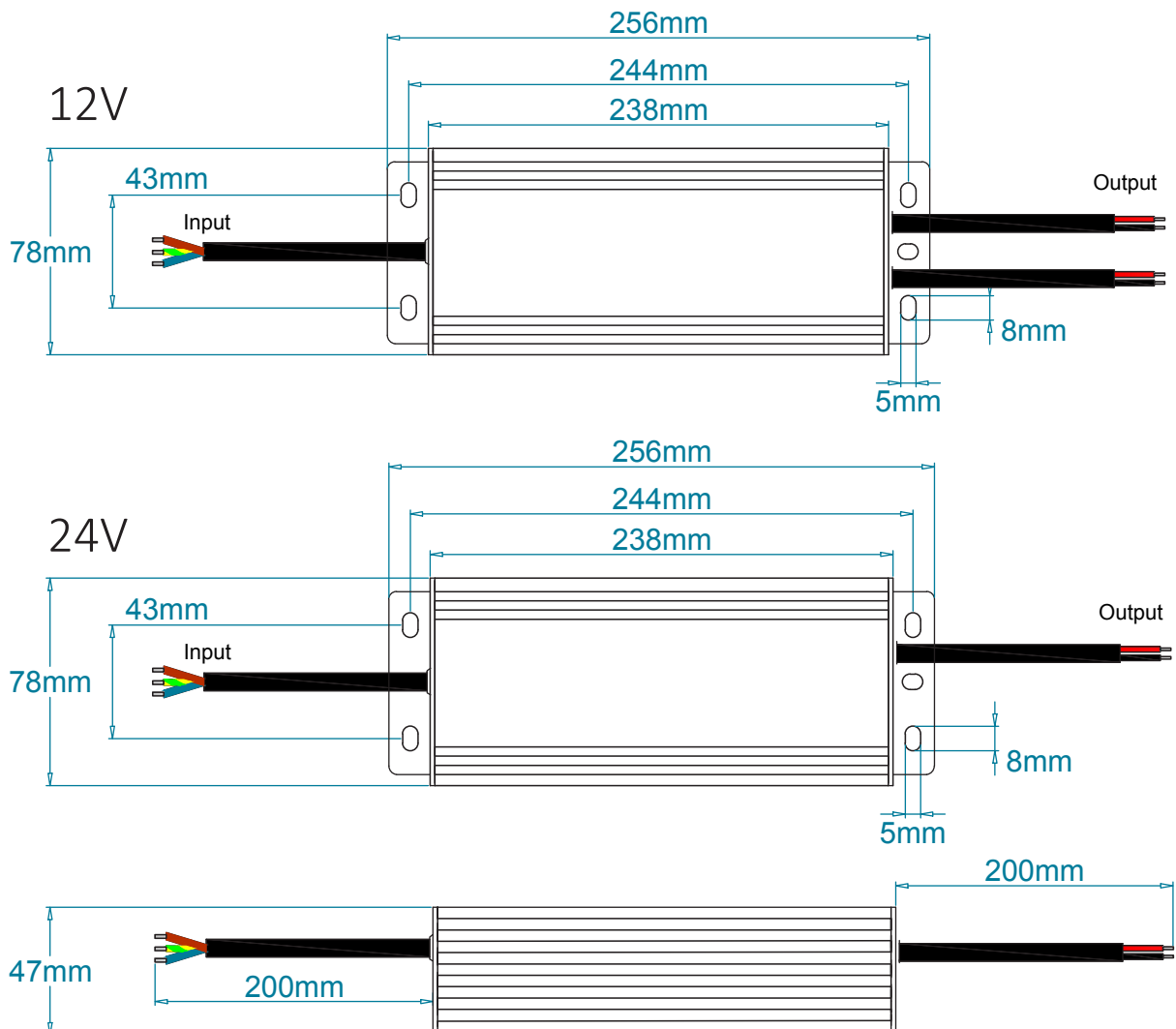

Derating Curve

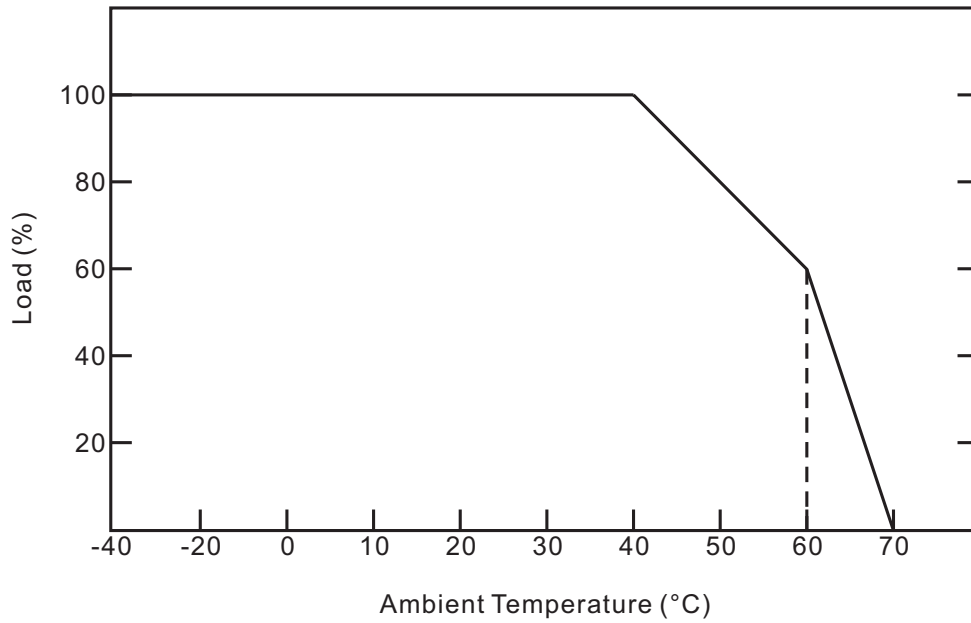

Connecting Diagram

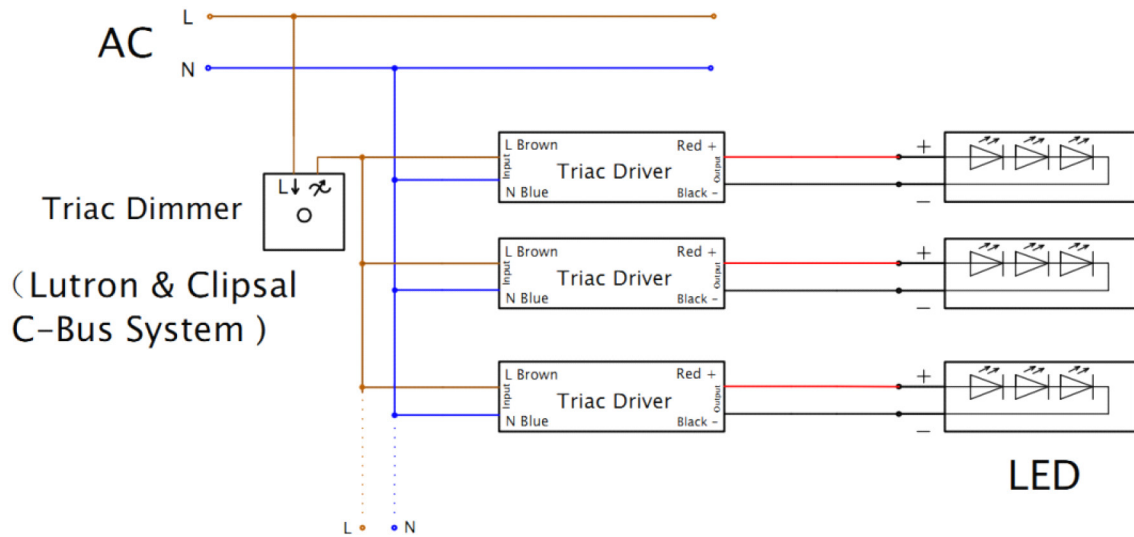

Connecting Diagram

