

Baru 10 Light Decking Kit

Instruction Manual

ZN 40065 & 40066

Ins ZN 40065 40066 - B

Product Specification:

LED deck light
 Input voltage: 100-240VAC ~ 50/60Hz
 Output voltage: 12VDC
 Lamp: 40065 - 10 x 0.5W LED module, 40066 - 10 x 1W LED module
 LED color: 40065 - RGB, 40066 - RGB+daylight white 6500K
 Product dimension: 40065 - Dia 30 x 0.4mm projection, 40066 - Dia 45 x 0.4mm projection
 Lumen output: 40066 - 200Lm at daylight white 6500K mode
 Deck cutout size: 40065 - Dia 24mm, 40066 - Dia 32mm
 Depth into Deck: Min. 35mm
 iOS 9.0 or higher, Android 4.4 or higher
 WiFi IEEE 802.11N, 2.4GHz

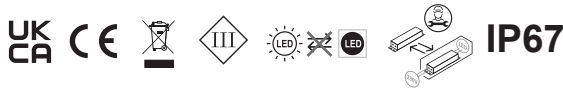

Warning:

- Install in accordance with the IEE Wiring regulations and current Building Regulations.
- This system operates at Safety Extra Low Voltage (12V), via a LED driver. Never connect the light fittings directly to the mains without using a LED driver
- Do not look directly into the light source.
- Do not attempt to disassemble any parts.
- LED driver can support a maximum of up to 10 LED light units. Do not attempt to connect further light units.
- The plug-in LED driver has no special protection against moisture and must be situated indoors.
- LED driver is not suitable for use with dimmers.
- Always disconnect the LED driver from the mains when installing or maintaining this system.
- This system contains non-replaceable parts and cannot be serviced. If damage occurs the part should be scrapped.
- The product is designed to be fitted horizontally and vertically in decking, walls, steps etc.. It is not suitable for installation directly into the ground.
- Waste electrical products should not be disposed of with household waste. Please recycle where facilities exist. Check with your local authority or retailer for recycling advice.
- This system works via WiFi control, please sure that BEFORE you install your kit there is good 2.4GHz WiFi signal coverage in the location you going to place the smart WiFi controller.
- Only support 2.4GHz WiFi networks with WEP and WPA/WPA2 encryptions. Portal and WPA/WPA2 enterprise are not supported.
- 5GHz WiFi is not supported un-secured open networks and hidden SSIDs are not supported.
- If you are experiencing problems, please consult a qualified electrician.

Installation:

- Note that the switch is turned off before installation.
- Plan the desired layout carefully, ensuring the cables will reach the distances between the LED driver and each LED light unit.
- Avoid locating any cables in positions that would cause a trip hazard. Position cables away from areas where they may be at risk from being cut, trapped or damaged.
- After deciding the layout, ensure the cables are long enough to connect to the desired positions.
- Drill the mounting holes for the LED light units taking care not to damage any pipes or mains cables beneath the mounting surface. These require a Dia 24mm (40065) Dia 32mm (40066) cutout hole.
- Feed the connector and cable of each LED light unit through the mounting holes and push unit into the hole to secure.
- Connect each LED light unit to the next LED light unit ensuring the arrows on connectors are facing each other and all connectors are fully fitted.
- Connect the extension cable and WiFi receiver to the LED driver.
- Connect the LED driver into the mains socket and switch on.

This product is suitable for dimming with 'Tuya' app, Amazon Echo or Google Home. We recommend putting the wifi receiver within 20-25 meters of your WI-FI Hub. This will vary depending on the strength of your WI-FI coverage. TUYA smart products are only supported on 2.4G WIFI bands. We recommend testing the position before full installation.

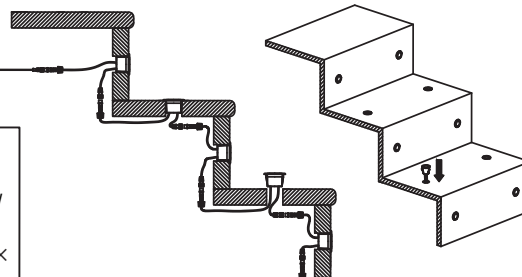
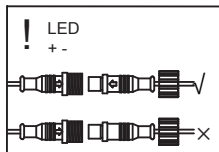
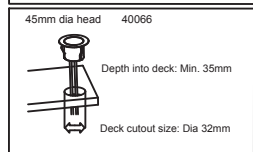
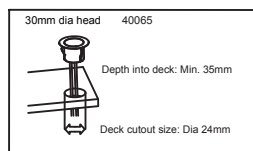
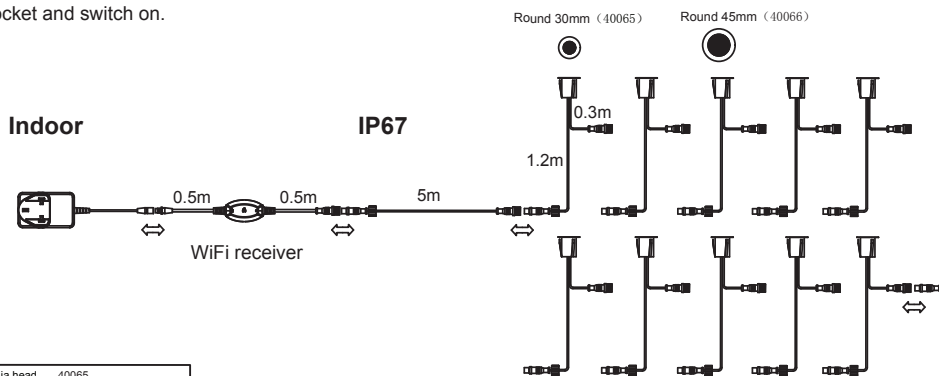

Care and maintenance:

It is recommended to regularly spray on or apply by a cloth a water displacing oil to clean and protect the metal surfaces. This will provide protection from the elements especially if living near the sea

Helpline

If you receive this item with parts broken or missing, please telephone: **0333 0050077**
 Please have ready your name, address, tel. no., product reference, where purchased and parts required. An answering service is in operation outside office hours and during busy periods. We regret that we are unable to give advice on internal house wiring.
 Cascade Holdings Ltd, Gorse Mill, Gorse Street, Chadderton, Oldham. OL9 9RJ

TUYA SMART INTELLIGENT LIGHTING USER MANUAL



App store



Google Play



App store/Google Play

STEP 1

You will need an active internet connection. Scan the QR code to download the App or login to Google Play or the App Store on your mobile phone or tablet and search 'Tuya Smart'. Click 'Download'. Once downloaded, click on the app to open and proceed to login or register.

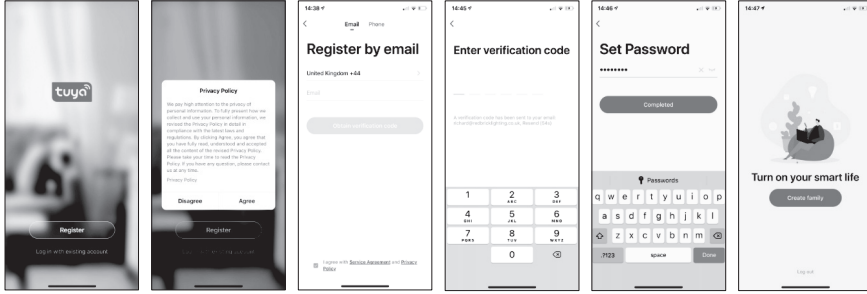

STEP 2

Read the Privacy Policy carefully. Click 'Agree' if you wish to continue with the setup. You can choose to register by email or phone; complete all required fields. Click 'Obtain verification code'.

Enter the verification code that you receive. Set a Password.

Welcome to Tuya Smart.

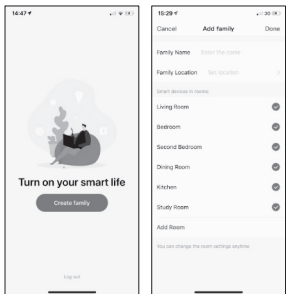

STEP 3

Click 'create family' to turn on your Tuya Smartlife.

Enter family name, or any name you wish.

Set location. Tick or untick relevant rooms according to the property.

If the room is not present, add a room, e.g.'Patio'. You can change room settings at anytime.

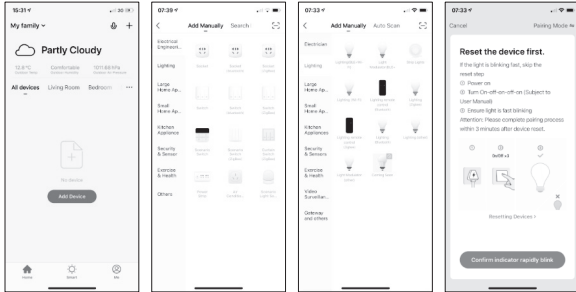

STEP 4

It is now time to add your smart lighting.

Click 'Add Device' or the '+' icon in the top right hand corner. Click 'Lighting' on the left hand side.

Click 'Lighting (BLE+Wi-Fi)' on the main screen.

Turn the light on and leave for 10 seconds.

Turn off and on repeatedly, 3 times (2-3 seconds between clicks)

When the light starts to blink repeatedly, click 'Confirm lights blink rapidly'.

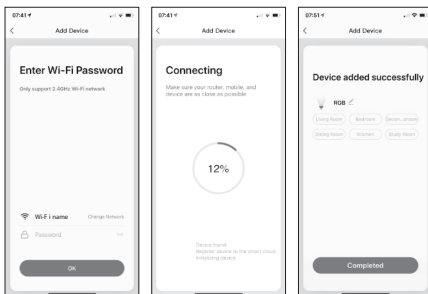

STEP 5

NOTE: Only supports 2.4 GHz Wi-Fi networks

Enter your Wi-Fi details and click 'OK'.

Once successfully connected, you can keep the default name or change it and assign the light to a room.

Finally, click 'Completed'. Congratulations, you are now free to enjoy controlling your light through the smart app.



STEP 6

Click the icon in the top right hand corner of the app to display additional options, such as pairing with your Amazon Alexa or Google Assistant.

Click an icon in the Supported Third-Party Control section.

Follow the connection instructions described here.